

# SUNLIFE POWER

## User Manual

INVERTER/MPPT SCC/AC CHARGER

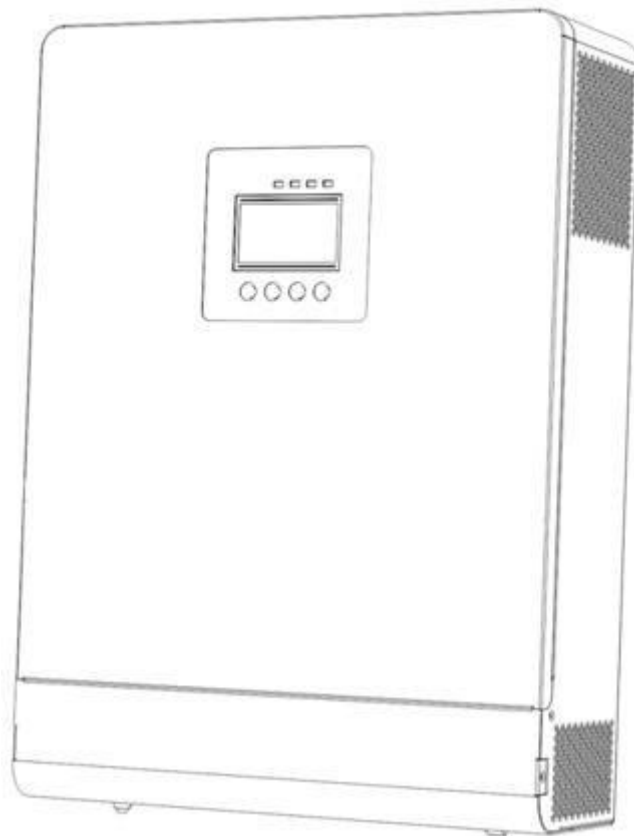

**Table Of Contents**

ABOUT THIS MANUAL ..... 1

Purpose..... 1

Scope..... 1

SAFETY INSTRUCTIONS ..... 1

INTRODUCTION ..... 2

Features .....	2
Basic System Architecture .....	2
Product Overview .....	3
Description of the central control board .....	4
INSTALLATION .....	6
Unpacking and Inspection .....	6
Preparation .....	6
Mounting the Unit .....	6
Battery Connection .....	7
AC Input / Output Connection .....	8
PV Module Wire Connection .....	11
Final Assembly .....	11
OPERATION .....	12
Power ON/OFF .....	12
Operation and Display Panel .....	12
LCD Display Icons .....	14
LCD Setting .....	16
Display Setting .....	26
Operating Mode Description .....	31
Error Reference Code .....	33
Warning Indicator .....	34
SPECIFICATIONS .....	35
Table 1 Utility Mode Specifications .....	35
Table 2 Inverter Mode Specifications .....	36
Table 3 Charge Mode Specifications .....	37
Table 4 General Specifications .....	37
TROUBLE SHOOTING .....	38
PARALLEL OPERATION GUIDE .....	40
Equipment running in parallel mode .....	40
Installation of equipment in parallel .....	40
Equipment parallel wiring .....	40
Single-phase parallel operation .....	43
Three-phase parallel operation .....	45

## ABOUT THIS MANUAL

### Purpose

This manual describes the assembly, installation, operation and troubleshooting of this unit. Please read this manual carefully before installations and operations. Keep this manual for future reference.

### Scope

This manual provides safety and installation guidelines as well as information on tools and wiring.

## SAFETY INSTRUCTIONS



**WARNING: This chapter contains important safety and operating instructions. Read and keep this manual for future reference.**

1. Before using the unit, read all instructions and cautionary markings on the unit, the batteries and all appropriate sections of this manual.
2. Do not disassemble the unit. Take it to a qualified service center when service or repair is required. Incorrect re-assembly may result in a risk of electric shock or fire.
3. To reduce risk of electric shock, disconnect all wirings before attempting any maintenance or cleaning. Turning off the unit will not reduce this risk.
4. **CAUTION** ⚠ Only qualified personnel can install this device with battery.
5. NEVER charge a frozen battery.
6. For optimal operation of this inverter/ charger, please follow required spec to select appropriate cable size. It's very important to correctly operate this inverter/charger.
7. Be very cautious when working with metal tool son or around batteries. A potential risk exists to drop a tool to spark or short circuit batteries or other electrical parts and could cause an explosion.
8. Please strictly follow installation procedure when you want to disconnect AC or DC terminals. Please refer to INSTALLATION section of this manual for the details.
9. One piece of 150A fuse is provided as over-current protection for the battery supply.
10. **GROUNDING INSTRUCTIONS** -This inverter/charger should be connected to a permanent grounded wiring system. Be sure to comply with local requirements and regulation to install this inverter.
11. NEVER cause AC output and DC input short circuited. Do NOT connect to the utility when DC input short circuits.
12. **Warning!!** Only qualified service persons are able to service this device. If errors still persist after following trouble shooting table, please send this inverter/charger back to local dealer or service center for maintenance.
13. **WARNING:** Because this inverter is non-isolated, only three types of PV modules are acceptable: single crystalline, poly crystalline with class A-rated and CIGS modules. To avoid any malfunction, do not connect any PV modules with possible current leakage to the inverter. For example, grounded PV modules will cause current leakage to the inverter. When using CIGS modules, please be sure NO grounding.
14. **CAUTION** ⚠ It's requested to use PV junction box with surge protection. Otherwise, it will cause damage on inverter when lightning occurs on PV modules.

## INTRODUCTION

This is a multi-function inverter/charger, combining functions of inverter, solar charger and battery charger to offer uninterruptible power support with portable size. Its comprehensive LCD display offers user-configurable and easy-accessible button operation such as battery charging current, AC/solar charger priority, and acceptable input voltage based on different applications.

### Features

- Pure sine wave inverter
- Inverter running without battery
- Configurable input voltage range for home appliances and personal computers via LCD setting
- Configurable battery charging current based on applications via LCD setting
- Configurable AC/Solar Charger priority via LCD setting
- Compatible to mains voltage or generator power
- Auto restart while AC is recovering
- Overload/ Over temperature/ short circuit protection
- Smart battery charger design for optimized battery performance
- Cold start function

### Basic System Architecture

The following illustration shows basic application for this inverter/charger. It also includes following devices to have a complete running system:

- Generator or Utility.
- PV modules.

Consult with your system integrator for other possible system architectures depending on your requirements.

This inverter can power all kinds of appliances in home or office environment, including motortype appliances such as tube light, fan, refrigerator and air conditioner.

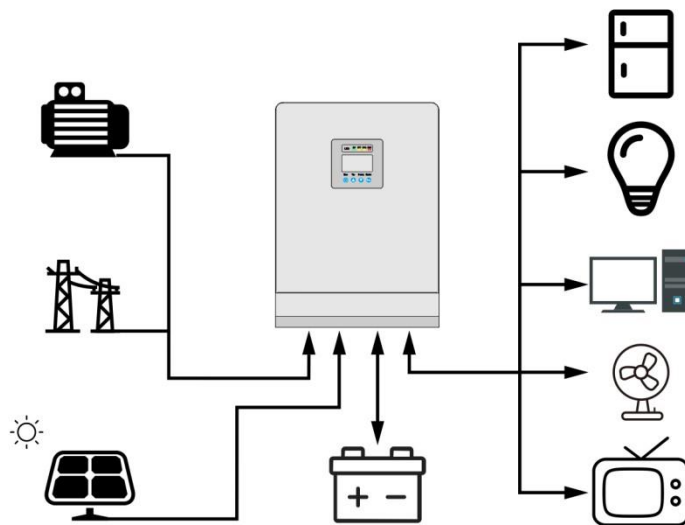
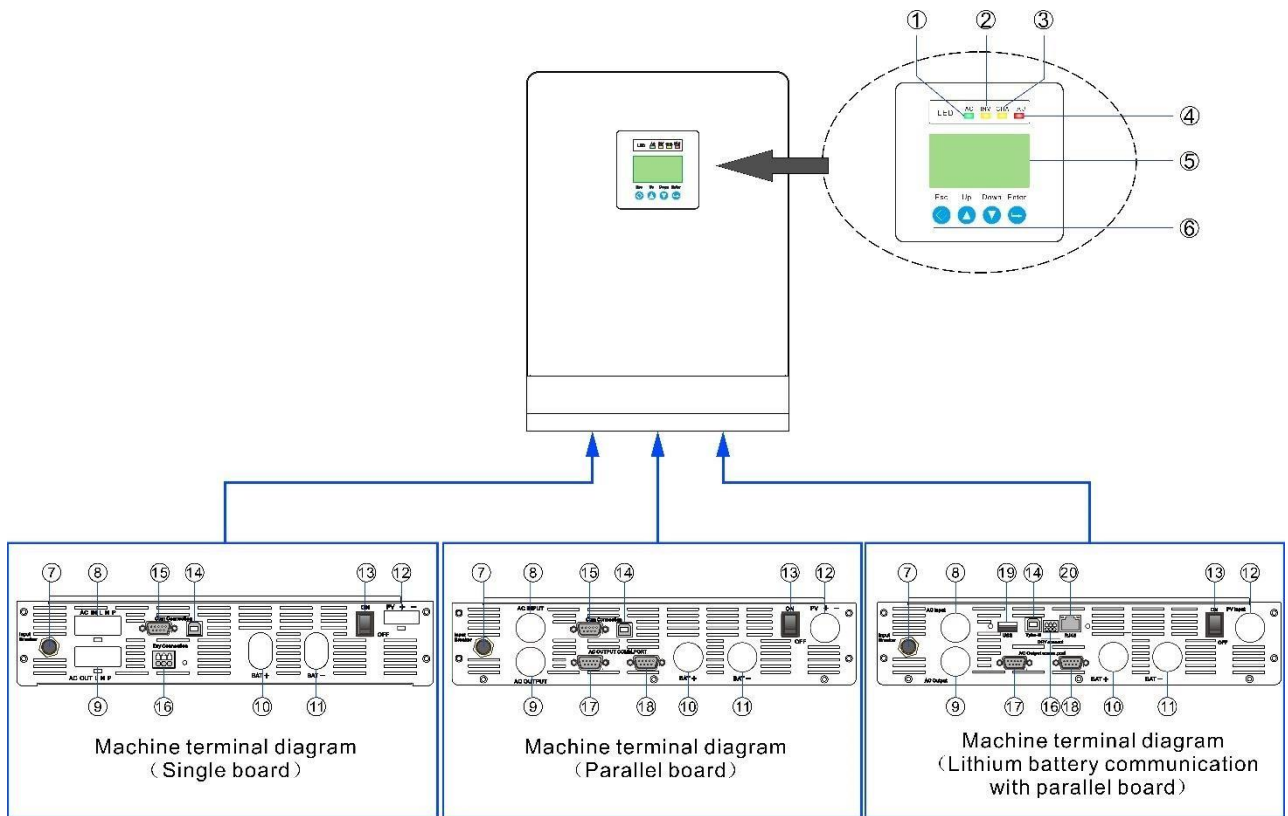

Figure 1 Hybrid Power System

## Product Overview



- |  |                                   |
|--|-----------------------------------|
| ①-- AC indicator                       | ②-- INV indicator                 |
| ③-- CHA indicator                      | ④-- FAU indicator                 |
| ⑤-- LCD display                        | ⑥-- Function buttons              |
| ⑦-- Re-settable over-current protector | ⑧-- AC input                      |
| ⑨-- AC output                          | ⑩-- Battery input positive        |
| ⑪-- Battery input negative terminal    | ⑫-- PV input                      |
| ⑬-- Power on/off switch                | ⑭-- USB Type-b communication port |
| ⑮-- RS232 communication port           | ⑯-- Parallel line port            |
| ⑰-- Parallel line port                 | ⑰-- Parallel line port            |
| ⑱-- USB communication port (WIFI/GPRS) | ⑲-- Parallel line port            |
|  | ⑳-- RJ45 communication port       |

## Description of the central control board

(Ignore this if the machine without this board)

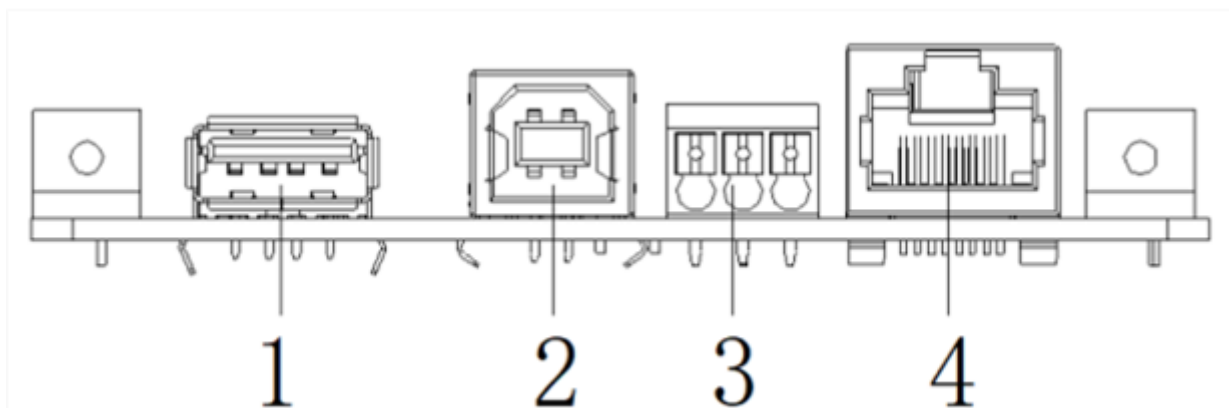

central control board			
NO	SYMBOL	DESCRIPTION	TYPE
1	CN1	USB communication port (WIFI/GPRS)	USB-TYPE-A
2	CN2	Type-B communication port	USB-TYPE-B
3	CN6	Dry connect	
4	CN11	RJ45 communication port	RJ45

### [1] CN1: USB communication port (WIFI/GPRS)

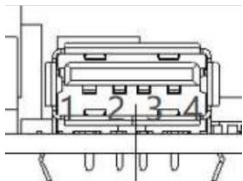
			
NO	SYMBOL	DESCRIPTION	
1	+5V	+5V Power	
2	RS.232.RX	Serial Wire Debug	
3	RS.232.TX	Serial Wire Clock	
4	GND	Ground	

### [2] CN2: TYPE-B communication port

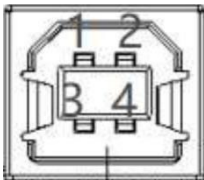
			
NO	SYMBOL	DESCRIPTION	

1	+5V	+5V Power
2	DM	Serial Wire Debug
3	DF	Serial Wire Clock
4	GND	Ground

**[3] CN6: Dry connect**

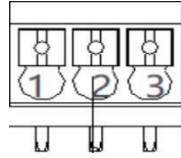

NO	SYMBOL	DESCRIPTION
1,6	DRY-CN1	DRY-CN1
2,5	COMMON	Common
3,4	DRY-CN2	DRY-CN2

**[4] CN11: RJ45 communication port**

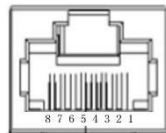

NO	SYMBOL	DESCRIPTION
1	RS485B	485B Communication interface
2	RS485A	485A Communication interface
3	NC	
4	CAN-BUS+	CAN+ Communication interface
5	CAN-BUS-	CAN- Communication interface
6	NC	
7	NC	
8	NC	



## INSTALLATION

### Unpacking and Inspection

Before installation, please inspect the unit. Be sure that nothing inside the package is damaged. You should have received the following items inside of package:

- Equipment \*1
- User manual \* 1
- Equipment support \*1
- Screws \*2
- Colloidal particle \*2
- 150A Fuse\*1
- Communication cable \*1 (Optional)

### Preparation

Before connecting all wirings, please take off bottom cover by removing two screws as shown below.

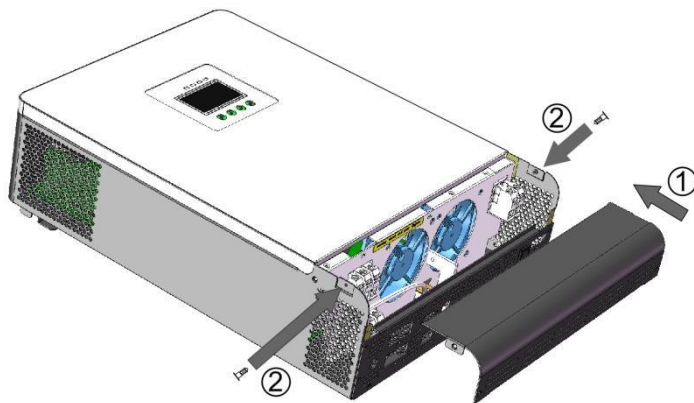

### Mounting the Unit

Consider the following points before selecting where to install:

- Do not mount the inverter on flammable construction materials.
- Mount on a solid surface

- Install this inverter at eye level in order to allow the LCD display to be read at all times.
- For proper air circulation to dissipate heat ,allow clearance of approx. 20 cm to the side and approx. 50 cm above and below the unit.
- The ambient temperature should be between 0' C and 55' C to ensure optimal operation.
- The recommended installation position is to be adhered to the wall vertically.
- Be sure to keep other objects and surfaces as shown in the diagram to guarantee sufficient heat dissipation and to have enough space for removing wires.

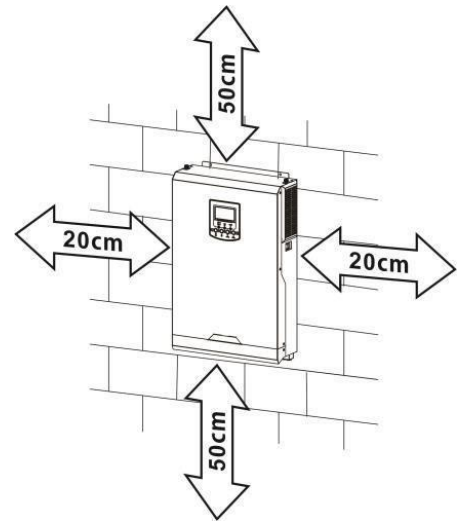

**⚠️ SUITABLE FOR MOUNTING ON CONCRETE OR OTHER NON-COMBUSTIBLE SURFACE ONLY.**

Install the unit by screwing 2 screws, as following picture shows.

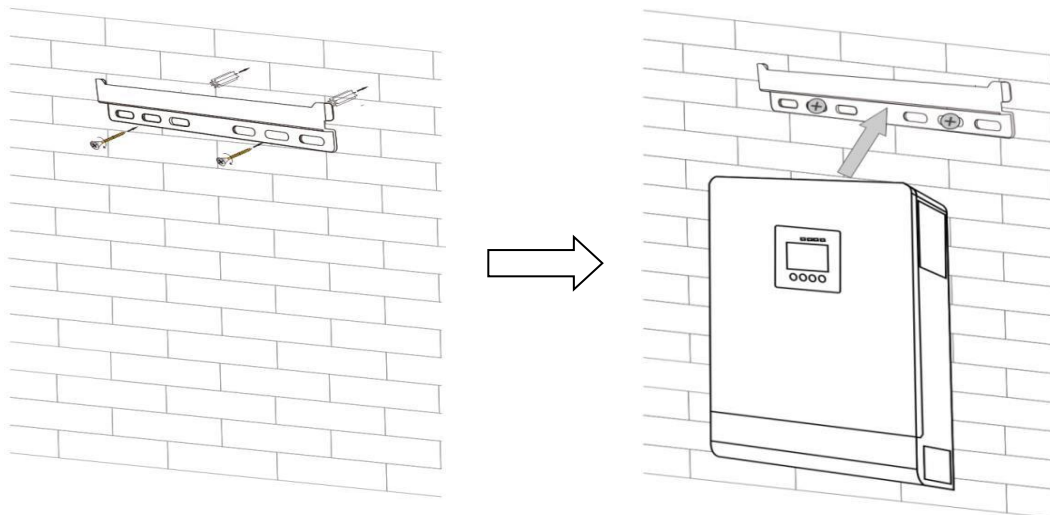

**Battery Connection**

**This model can be operated without battery connection. Connect to battery if necessary.**

**CAUTION :**For safety operation and regulation compliance ,it's requested to install a separate DC over-current protector or disconnect device between battery and inverter. It may not be requested to have a disconnect device in some applications, however, it's still requested to have over-current protection installed. Please refer to typical amperage in below table as required fuse or breaker size.

**WARNING!** All wiring must be performed by a qualified personnel.

**WARNING!** It's very important for system safety and efficient operation to use appropriate cable for battery connection. To reduce risk of injury, please use the proper recommended cable as below.

Recommended battery cable size:

Model	Wire Size	Cable (mm <sup>2</sup> )	Torque Value (max)
5.5KVA	1 x 2AWG	35	2 Nm

Please follow below steps to implement battery connection:

1. Connect all battery packs as below chart.

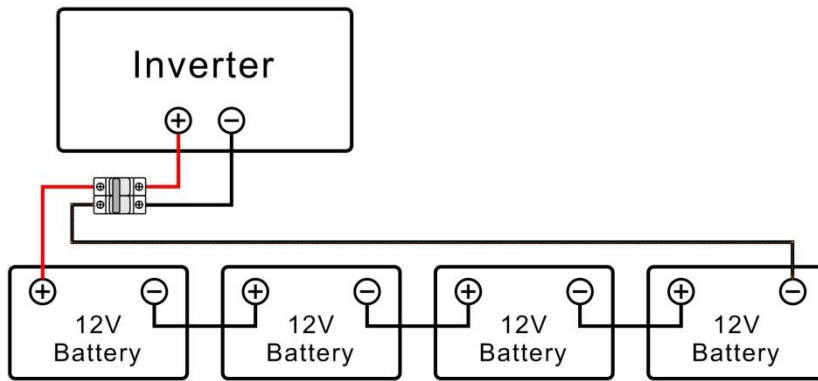

5.5KVA

2. Insert the battery wires flat to battery connectors of inverter and make sure the bolts are tightened with torque of 2 Nm in clockwise direction. Make sure polarity at both the battery and the inverter/charge is correctly connected and conductors are tightly screwed into the battery terminals.

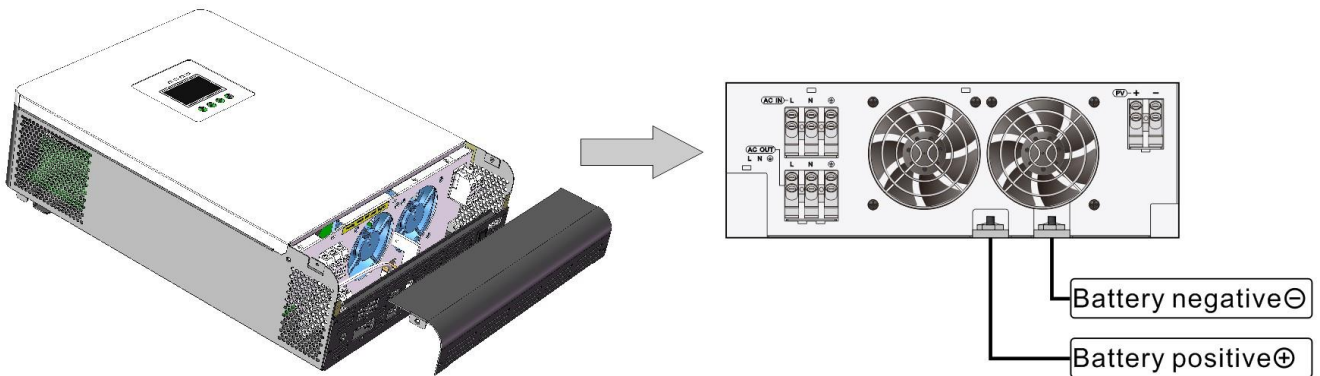

	<p><b>WARNING: Shock Hazard</b> Installation must be performed with care due to high battery voltage in series.</p>
--	---

	<p><b>CAUTION!!</b> Before making the final DC connection or closing DC breaker / disconnect , be sure positive (+) must be connected to positive (+) and negative (-) must be connected to negative (-).</p>
--	---

**AC Input / Output Connection**

**CAUTION!!** Before connecting to AC input power source, please install a separate AC breaker between inverter and AC input power source. This will ensure the inverter can be securely disconnected during maintenance and fully protected from over current of AC input. The recommended AC circuit breaker is 50A .

**CAUTION!!** There are two terminal blocks with  $\text{RINUL}$  and  $\text{ROUTUL}$  markings. Do not mistakenly connect the input and output cables

**WARNING!** All wiring must be performed by a qualified personnel.

**WARNING!** It's very important for system safety and efficient operation to use appropriate cable for AC input connection. To reduce risk of injury, please use the proper recommended cable size as below.

**Suggested cable requirement for AC wires**

Model	Gauge	Cable (mm <sup>2</sup> )	Torque Value (max)
5.5KVA	10 AWG	6	1.2 Nm

Please follow below steps to implement AC input/output connection:

1. Before making AC input/output connection, be sure to open DC protector or disconnecter first.
2. Insert AC input wires according to polarities indicated on terminal block and tighten the terminal screws .Be sure to connect PE protective conductor(⊕) first.

⊕ → **Ground (yellow-green)**      **L** → **LIVE (brown or black)**      **N** → **Neutral**  
**(blue)**

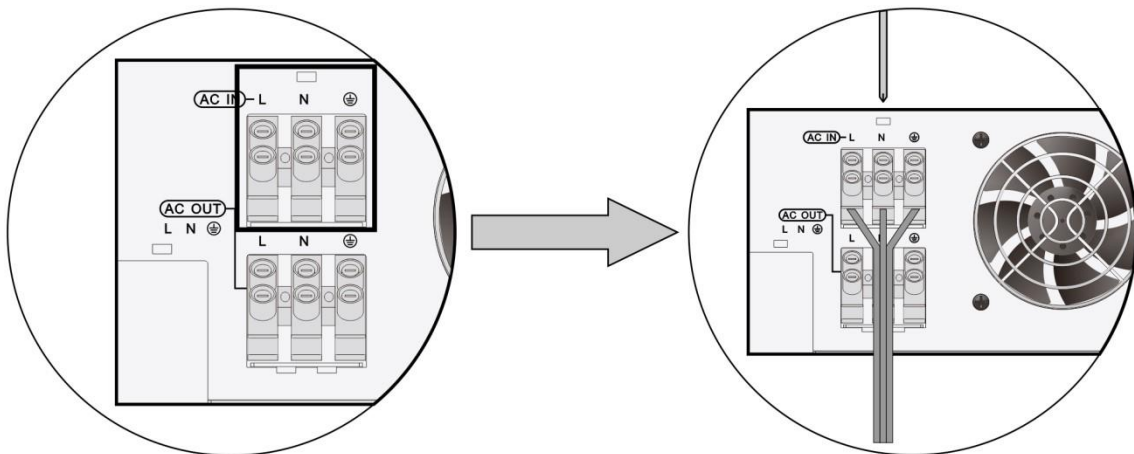

	<p><b>WARNING:</b>          Be sure that AC power source is disconnected before attempting to hardwire it to the unit.</p>
---	--

1. Then insert AC output wires according to polarities indicated on terminal block and tighten terminal screws. Be sure to connect PE protective conductor(⊕) first.

⊕ → **Ground (yellow-green)**      **L** → **LIVE (brown or black)**      **N** → **Neutral**  
**(blue)**

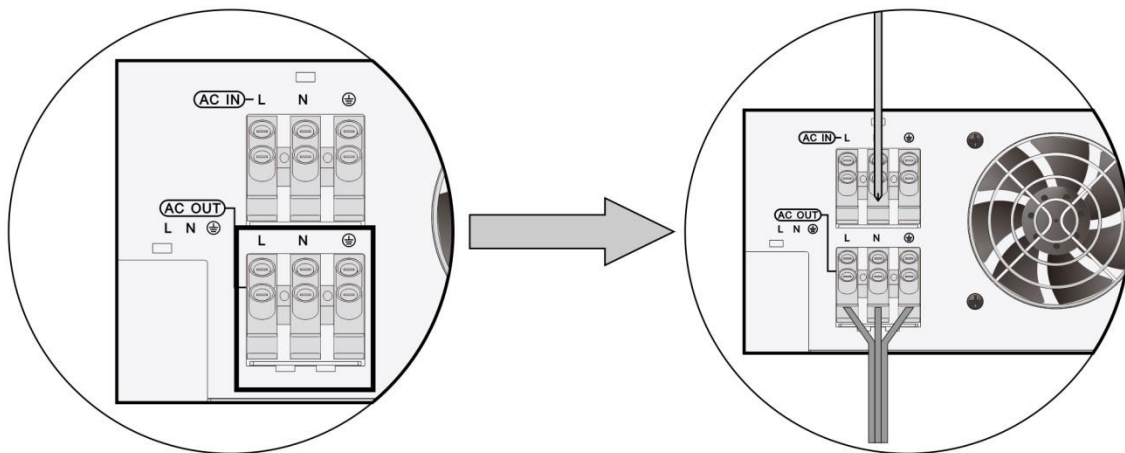

2. Make sure the wires are securely connected.

**CAUTION:** Appliances such as air conditioner are required at least 2~3 minutes to restart because it's required to have enough time to balance refrigerant gas inside of circuits. If a power shortage occurs and recovers in a short time, it will cause damage to your connected appliances. To prevent this kind of damage, please check manufacturer of air conditioner if it's equipped with time-delay function before installation. Otherwise, this inverter/charger will trig over load fault and cut off output to protect your appliance but sometimes it still causes internal damage to the air conditioner.

### PV Connection

**CAUTION :** Before connecting to PV modules ,please install separately a DC circuit breaker between inverter and PV modules.

**WARNING!** It's very important for system safety and efficient operation to use appropriate cable for PV module connection. To reduce risk of injury, please use the proper recommended cable size as below.

Model	Wire Size	Cable(mm <sup>2</sup> )	Torque Value (max)
5.5KVA	1 x 12AWG	4	1.2 Nm

**WARNING:** Because this inverter is non-isolated, only three types of PV modules are acceptable: single crystalline, poly crystalline with class A-rated and CIGS modules. To avoid any malfunction, do not connect any PV modules with possible current leakage to the inverter. For example, grounded PV modules will cause current leakage to the inverter. When using CIGS modules, please be sure NO grounding.

**CAUTION:** It's requested to use PV junction box with surge protection. Otherwise, it will cause damage on inverter when lightning occurs on PV modules.

### PV Module Selection:

When selecting proper PV modules, please be sure to consider below parameters:

1. Open circuit Voltage (Voc) of PV modules not exceeds max. PV array open circuit voltage of inverter.
2. Open circuit Voltage (Voc) of PV modules should be higher than min. battery voltage.

3. Voltage range of the photovoltaic module, as shown below.

INVERTER MODEL	5.5KVA
Max. PV Array Open Circuit Voltage	450Vdc
PV Array MPPT Voltage Range	120Vdc~430Vdc
Maximum power of photovoltaic array	5500Wp

Take 375Wp PV module as an example. After considering above two parameters, the recommended module configurations are listed as below table.

Solar Panel Spec. (reference) - 375Wp Vm:34.4Vdc Im:10.9A Voc:41.2Vdc Isc:11.4A	SOLAR INPUT	Qty of panels	Total input power
	(Min in serial: 4, max. in serial: 10)		
	8 pcs in serial-5.5KVA	8 pcs	3000W
	10 pcs in serial-5.5KVA	10 pcs	3750W
	7 series 2 parallel-5.5KVA	14 pcs	5250W

**PV Module Wire Connection**

Check correct polarity of wire connection from PV modules and PV input connectors .Then connect positive pole (+) of connection wire to positive pole (+) of PV input connector. Connect negative pole (-) of connection wire to negative pole (-) of PV input connector. Screw two wires tightly in clockwise direction. Recommended tool: 4mm blade screwdriver.

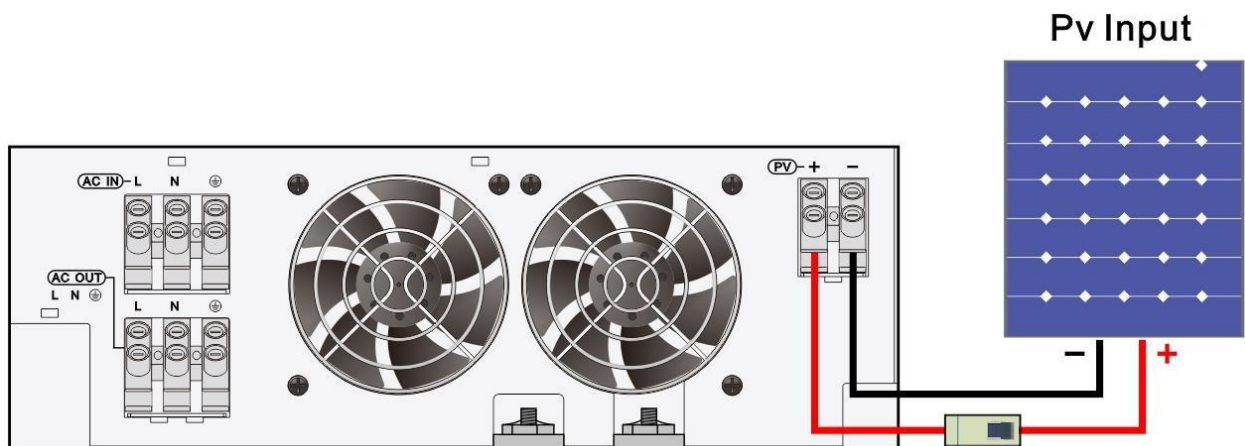

**Final Assembly**

After connecting all wirings, please put bottom cover back by screwing two screws as shown below.

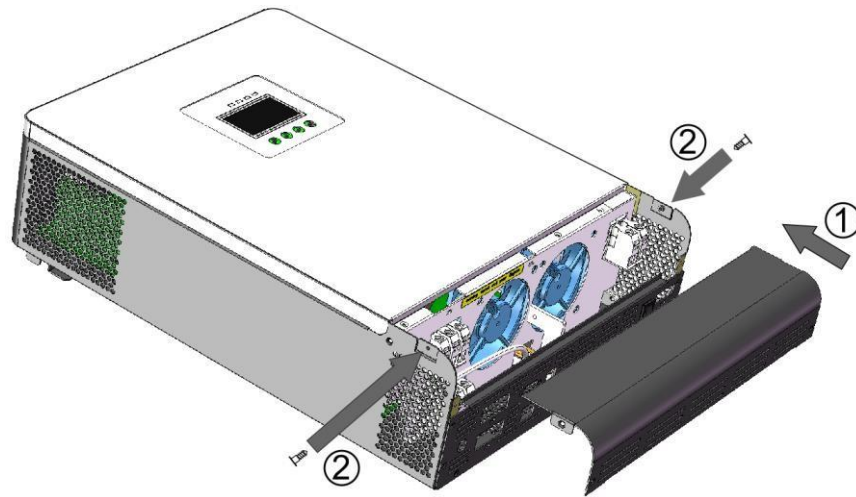

## OPERATION

### Power ON/OFF

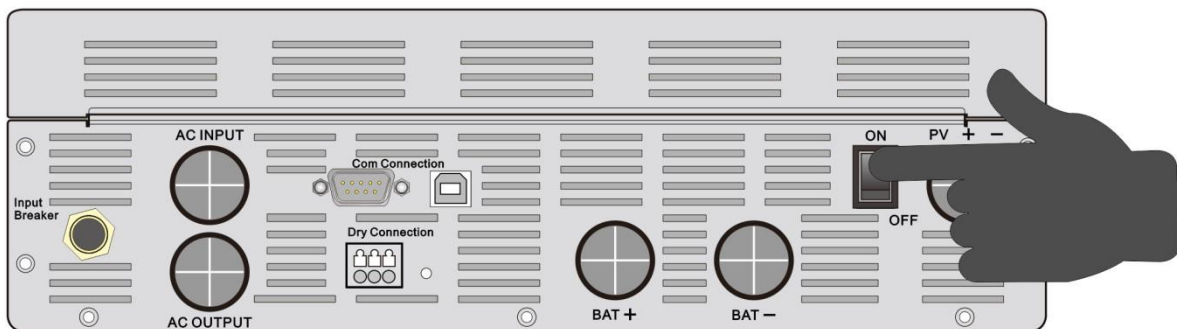

Once the unit has been properly installed and the batteries are connected well ,simply press On/Off switch (located on the button of the case) to turn on the equipment.

### Operation and Display Panel

The operation and display panel, shown in below chart, is on the front panel of the inverter. It includes four indicators, four function keys and a LCD display, indicating the operating status and input/output power information.



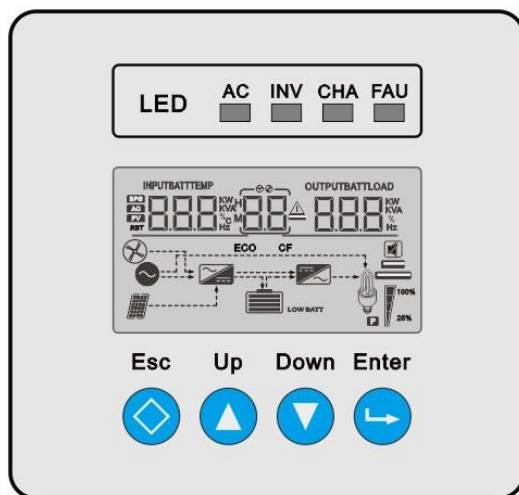

### LED Indicator

LED Indicator		Messages	
AC	Green	Solid On	The utility is normal and the utility is working
		Flashing	The utility is normal, but the utility is not working
		Slake	Utility abnormal
INV	Yellow	Solid On	The machine works in battery mode output
		Flashing	Other states
CHA	Yellow	Solid On	The battery is on floating charging
		Flashing	The battery charged at constant voltage
		Slake	Other states
FAU	Red	Solid On	Fault occurs in the inverter.
		Flashing	Warning condition occurs in the inverter.
		Slake	Inverter normal

### Function Keys

Function Key	Description
--------------	-------------



ESC	To exit setting mode
UP	To go to previous selection
DOWN	To go to next selection
ENTER	To confirm the selection in setting mode or enter setting mode

### LCD Display Icons

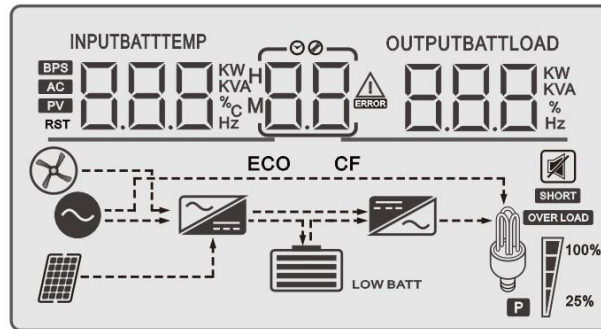









Icon	Function description
<b>Input Source Information</b>	
<b>AC</b>	Indicates the AC input.
<b>PV</b>	Indicates the PV input
<b>INPUTBATT</b> 	Indicate input voltage, input frequency, PV voltage, charger current (PV charging), charger power, battery voltage.
<b>Configuration Program and Fault Information</b>	
	Indicates the setting programs.
	Indicates the warning and error codes.
	Warning: flashing with warning code.
	Error: lighting with fault code
<b>Output Information</b>	
<b>OUTPUTBATTLOAD</b> 	Indicate output voltage, output frequency, load percent, load in VA, load in Watt and discharging current.
<b>Battery Information</b>	
	Indicates battery level by 0-24%, 25-49%, 50-74% and 75-100% in battery mode and charging status in line mode.

In AC mode, it will present battery charging status.

Status	Battery voltage	LCD Display
Constant Current mode / Constant Voltage mode	<2V/cell	4 bars will flash in turns.
	2 ~ 2.083V/cell	Bottom bar will be on and the other three bars will flash in turns.
	2.083 ~ 2.167V/cell	Bottom two bars will be on and the other two bars will flash in turns.
	> 2.167 V/cell	Bottom three bars will be on and the top bar will flash.
Floating mode. Batteries are fully charged.		4 bars will be on.

In battery mode, it will present battery capacity

Load Percentage	Battery Voltage	LCD Display
Load >50%	< 1.85V/cell	
	1.85V/cell ~ 1.933V/cell	
	1.933V/cell ~ 2.017V/cell	
	> 2.017V/cell	
Load < 50%	< 1.892V/cell	
	1.892V/cell ~ 1.975V/cell	
	1.975V/cell ~ 2.058V/cell	
	> 2.058V/cell	

#### Load Information

**OVER LOAD**

Indicates overload

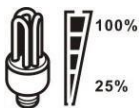

Indicates the load level by 0-24%, 25-49%, 50-74% and 75-100%.

0%~24%

25%~49%

50%~74%

75%~100%



#### Mode Operation Information



Indicates unit connects to the utility.



Indicates unit connects to the PV panel.

**BYPASS**

Indicates load is supplied by utility power.



Indicates the utility charger circuit is working.



Indicates the DC/AC inverter circuit is working.









## Mute Operation









Indicates unit alarm is disabled.

### LCD Setting

After pressing and holding ENTER button for 3 seconds, the unit will enter setting mode. Press  $\blacktriangle$  or  $\blacktriangledown$  button to select setting programs. And then, press  $\blacktriangleright$  button to confirm the selection or ESC button to exit. **Setting Programs:**

Program	Description	Selectable option	
01	Output voltage	 208V	 220V
		230V (default) 	240V 
02	Output frequency	50Hz (default) 	60Hz 
		This parameter can be set in the standby or mains bypass mode. Restart takes effect	
03	Output source priority	GRD Utility priority (default) 	Utility will provide power to the loads as first priority . Solar and battery energy will provide power to the loads only when utility power is not available.
		PV Solar priority 	The PV module preferentially supplies power to the load . When the photovoltaic modules are not powerful enough to power all the loads, the mains supply power to the loads at the same time. When mains power is unavailable, both the PV modules and the batteries provide power to the load. Logic diagram: PV > Grid > BAT

		PBG priority 	The PV module preferentially supplies power to the load . When the photovoltaic modules are not powerful enough to power all the loads, the battery supplies power to the loads at the same time. The mains will power the load as the first priority only when the battery voltage drops to the low voltage alarm value or the value set in program 15. Logic diagram: PV > BAT > Grid
--	--	---	---

04	Output mode	Appliance (default) 	Used for household appliances.
		UPS 	Used for equipment such as computers.
05	Setting the charger priority	If this inverter/charger is work mode, the charger priority can be programmed as follows:	ing in Utility, Standby or Error mode can be programmed as follows:
		GRD Utility priority 	Both the mains and the photovoltaic modules charge the battery.
		PV Solar priority 	Solar energy will charge battery as first priority .Utility will charge battery only when solar energy is not available.
		PNG Solar and Utility (default) 	The photovoltaic module is preferred to charge the battery, and the lack of charging energy is made up by the mains electricity.
		OPV Only Solar 	Solar energy will be the only charger source no matter utility is available or not.
		When the inverter is operating in battery mode or energy saving mode, only the photovoltaic module charges the battery, and the battery is charged only when the photovoltaic module is fully powered.	

06	Utility charging current Note: If setting value in program 07 is smaller than that in program in 06, the inverter will apply charging current from program 07 for utility charger. (5.5KVA is 2A80A)	2A ACC 06 2 <sup>A</sup>	10A ACC 06 10 <sup>A</sup>
		20A ACC 06 20 <sup>A</sup>	30A (5.5KVA default) ACC 06 30 <sup>A</sup>
		40A ACC 06 40 <sup>A</sup>	50A ACC 06 50 <sup>A</sup>
		60A ACC 06 60 <sup>A</sup>	80A ACC 06 80 <sup>A</sup>

07	Maximum charging current: To configure total charging current for solar and utility chargers. (Max . charging current= utility charging current + solar charging current) (5.5KVA is 2A80A)	2A ACC 07 2 <sup>A</sup>	10A ACC 07 10 <sup>A</sup>
		20A ACC 07 20 <sup>A</sup>	30A ACC 07 30 <sup>A</sup>
		40A ACC 07 40 <sup>A</sup>	50A ACC 07 50 <sup>A</sup>
		60A (default) ACC 07 60 <sup>A</sup>	70A ACC 07 70 <sup>A</sup>
		80A ACC 07 80 <sup>A</sup>	

08	Display interface Settings:	Return to default display screen (default) ndF 08 0N	If selected, no matter how users switch display screen, it will automatically return to default display screen (Input voltage / output voltage) after no button is pressed for 1 minute.
		Stay in the current display interface ndF 08 OFF	If selected, the display screen will stay at latest screen user finally switches.

09	Auto restart when overload occurs	Restart disable LFS 09 OFF	Restart enable(default) LFS 09 0N
----	-----------------------------------	-------------------------------	--------------------------------------

10	Auto restart when over temperature occurs	Restart disable ET5 10 OFF	Restart enable(default) ET5 10 ON
11	Beeps while primary source is interrupted	Alarm on (default) ALP 11 ON	Alarm off ALP 11 OFF
12	Energy-saving mode	When battery constant voltage charging is set to ON and the load is lower than 25W in battery mode, the system stops output for a short time and then continues. If the load is higher than 35W, the system returns to normal output.	
		On PUS 12 ON	Off (default) PUS 12 OFF

13	Overload bypass: If the device is overloaded in battery mode, the device switches to the utility mode.	Bypass disable (default) OLG 13 OFF	Bypass enable OLG 13 ON
14	Alarm control	Alarm on ALP 14 ON	Alarm off (default) ALP 14 OFF
15	Setting voltage point back to utility source when selecting RSBU priority in program 03.	5.5KVA default setting: 46.0V bTG 15 46.0V	
		When the battery and the mains exist at the same time, the main battery will be transferred to the mains to ensure that the battery will not be empty. Setting range is from 44.0V to 52.0V for 5.5KVA model. Increment of each click is 0.1V.	
16	Setting voltage point back to battery mode when selecting RSBU priority in program 03.	5.5KVA default setting: 52.0V bTB 16 52.0V	
		When the battery is powered off at low voltage, only when the battery voltage reaches a certain value, inverter can restart the battery mode. Setting range is from 48.0V to 58.0V for 5.5KVA model. Increment of each click is 0.1V.	
17	Battery type	AGM (default) Lead-acid battery BAT 17 AGM	FID (Flooded) BAT 17 FLD

		CUS User-Defined BAL 17 CUS	LIB (Lithium battery) BAL 17 LIB
		If $\mathbb{R}$ User-Defined $\cup$ is selected, Battery voltage parameters can be set in programs 18, 19, 20, and 21.	
18	Battery voltage alarm low	5.5KVA default setting: 44.0V BAL 18 44.0 <sup>v</sup>	
		If self-defined is selected in program 17, this program can be set up. Setting range is from 42V to 54V for 5.5KVA model. Increment of each click is 0.1V.	
19	Battery low voltage protection voltage	5.5KVA default setting: 42.0V BAL 19 42.0 <sup>v</sup>	
		If self-defined is selected in program 17, this program can be set up. Setting range is from 48.0V to 60.0V for 5.5KVA model. Increment of each click is 0.1V.	
20	Constant charging voltage of the battery	(The constant voltage should be greater than the floating charging voltage)	
		5.5KVA default setting: 56.4V BCV 20 56.4 <sup>v</sup>	
		If self-defined is selected in program 17, this program can be set up. Setting range is from 48.0V to 60.0V for 5.5KVA model. Increment of each click is 0.1V.	
21	Floating charging voltage	5.5KVA default setting: 54.0V BFL 21 54.0 <sup>v</sup>	
		If self-defined is selected in program 17, this program can be set up. Setting range is from 48V to 60V for 5.5KVA model. Increment of each click is 0.1V.	
22	Utility low voltage protection	Default setting: 154V LLV 22 154 <sup>v</sup>	
		Setting range is from 90V to 154V. Increment of each click is 1V.	
23	Utility high voltage protection	Default setting: 264V LHV 23 264 <sup>v</sup>	
		Setting range is from 264V to 280V. Increment of each click is 1V.	

24	Low power discharge time setting	Default setting: 8H Lud 24 8	
		Setting range is from 1H to 8H. Increment of each click is 1V. In reserved battery mode, if not reached the battery shutdown point after the duration exceeds the set hour, the system changes the battery shutdown point to 11V x the number of batteries. If the battery discharge reaches 11V x the number of batteries, the system alarms for 1 minute before shutting down. If the battery voltage exceeds 13.2V x the number of batteries exceeds 30 seconds, the battery discharge time is reset.	
25	Soft start setting of Inverter	On StE 25 ON	Off (default) StE 25 OFF
		When set to ON, the inverter output gradually increases from 0 to the target voltage. When set to OFF, the inverter output increases directly from 0 to the target voltage value.	



26	Restore the default values	On Std 26 ON	Off (default) Std 26 OFF
		(Mains and standby modes can be set and take effect immediately, battery mode cannot be set)	
27	Parallel mode setting	When using the parallel function, connect the parallel devices in the correct way, and set the parallel mode of each device correctly. If there is a dual system, the device set to SIG in the parallel mode reports fault 20. If there are devices set to 3P1, 3P2, or 3P3 in the parallel modes, and at least one device exists in each mode, otherwise all devices set to these three modes report error 20.	
		SIG default (single phase mode) PARn 27 SIG	PAR (single phase parallel mode) PARn 27 PAR
		3P1(R phase mode) PARn 27 3P1	3P2(S phase mode) PARn 27 3P2





		3P3(T phase mode) PAR 27 3P3	
		(Mains and standby mode can be set and take effect immediately, battery mode cannot be set) After the setting and merging are successful, a single device cannot be turned on, and it can be turned on only after undoing the parallel a	
28	Battery missed alarm	ON SbA 28 ON	OFF (default) SbA 28 OFF
		Set to OFF, when the battery is not connected, there will be no battery missed, battery low voltage, battery undervoltage alarm.	
29	Equilibrium mode	ON E9n 29 ON	OFF(default) E9n 29 OFF
		The default setting is OFF, and the function is not enabled; set to ON, when the equalization interval (battery equalization cycle) is set during the floating charge phase, or when equalization is immediately activated, the controller will begin to enter the equalization phase.	
30	Equalization voltage point setting	5.5KVA defaults 58.4V and 48V-60V can be set E9v 30 58.4v	
31	Equalization charging time setting	The default setting is 60 minutes, the range can be set from 5 to 900, and the increment is 5 minutes at a time. E9t 31 060	
		In the equalization charging stage, the inverter will charge the battery as much as possible, and only after completing the set equalization charging time will it return to the floating charging stage.	
32	Equalization delay charging time setting	The default setting is 120 minutes, but the setting range is 5-900, and the increment is 5 minutes at a time. E9d 32 120	

		In the equalization charging stage, after the battery equalization charging time is completed, if the voltage rises to the battery equalization voltage point, the inverter does not perform equalization delay charging time and directly returns to the floating charge stage. If the voltage does not rise to the battery equalization voltage point, the inverter will perform equalization delay charging time. During the equalization delay charging time, the voltage rises to the battery equalization voltage point and immediately returns to the floating charging stage. If it does not rise to the battery equalizing voltage point, it returns to the floating charging stage after completing the set equalizing delayed charging time.
33	Equalization charging interval setting	<p>The default setting is 30 days, the range can be set from 1 to 90, and the increment is 1 day at a time.</p> <p style="text-align: center;">E91 33 30d</p> <p>In the floating charging phase when the equalizing charging mode is turned on, when the battery is detected, the inverter will start to enter the equalizing phase when the set equalizing interval (battery equalizing period) is reached.</p>
34	Turn on the equilibrium mode immediately	<p>The default setting is OFF, and the function is not enabled; when set to ON, when the floating charge phase in equalization mode is turned on and battery access is detected, the equalization charge is activated immediately and the controller will begin to enter the equalization phase.</p> <p style="text-align: center;">E97 34 OFF</p>

35	On-grid inverter function (reserved)	ON	E61 35 ON	OFF(default)	E61 35 OFF
		<p>Set whether the inverter is grid-connected to feed power in PV priority mains mode or PBG mains mode.</p> <p>The default setting is OFF, and the function is not enabled; when it is set to ON, the inverter conducts maximum power point tracking, and the excess energy is fed into the mains. After the function is enabled, if a communication abnormality occurs, an alarm 56 will be generated, and the inverter will no longer determine the operation logic based on the BMS information.</p>			

36	Battery dual output voltage shutdown point (reserved)	5.5KVA defaults to 48.0V, and the range can be set to 44V60V. 
		When enabled, the secondary output of the inverter is enabled by default. After entering the battery mode, when the battery voltage is lower than the set point, the secondary output is turned off. When the battery voltage is higher than the set value + 1V/cell again, the secondary output is turned on.
37	Battery dual output duration (reserved)	5.5KVA is OFF by default, the function is not enabled, and the range can be set from 5 to 899 minutes. 
		When enabled, the secondary output of the inverter is enabled by default. After entering the battery mode, when the battery discharge time reaches the set point, the secondary output will be turned off. When it is set to FUL, the output time of the secondary output is not limited.

38	BMS communication function  This function needs to be used in conjunction with the central control board.	ON 	OFF (default) 
		The default setting is OFF, and the function is not enabled. When it is set to ON, the inverter communicates with the lithium battery BMS through the central control board, and obtains battery information. After the function is enabled, if there is a communication abnormality, an alarm 56 will be generated, and the inverter will no longer determine the operation logic based on the BMS information.	

39	<p>Low SOC Shutdown Function (SBU)</p> <p>This function needs to be used in conjunction with the central control board.</p>	<p>The default setting is 20, the setting range is [5,50], and it can be set to OFF.</p> 
		<p>In battery mode, when the lithium battery SOC reaches the set value, it will shut down and alarm 68 will be issued at the same time, and alarm 68 will be cleared when it returns to the set value + 5%. When in standby mode, it will enter battery mode only when it reaches the set value + 10%, and it will alarm 69 if it is not reached. After the function is turned on, when the lithium battery SOC reaches the set value + 5%, the alarm 69 will be issued, and the alarm 69 will be cleared when it returns to the set value + 10%. It can be set to OFF. At this time, the inverter will no longer perform shutdown, startup, and alarm operations according to the SOC situation. After the function is enabled, if a communication abnormality occurs, the inverter will no longer determine the operation logic based on the SOC information, and clear the relevant alarm.</p>

40	<p>High SOC to battery function</p>	<p>The default setting is 90, and the settable range is [10,100]. Can be set to OFF.</p> 
----	-------------------------------------	--





	This function needs to be used in conjunction with the central control board.	PBG priority mains normal mains mode, switch to battery mode when the lithium battery SOC reaches the set value. When turned on, the inverter will switch to battery mode only when the SOC is higher than the set point and the battery voltage is higher than the switch back to battery mode voltage point (see item 15). It can be set to OFF. At this time, the inverter will no longer switch from mains mode to battery mode according to the SOC situation. After the function is enabled, if a communication abnormality occurs, the inverter will no longer determine the operation logic based on the SOC information, and clear the relevant alarm.
41	<p>Low SOC to mains grid function (STG)</p> <p>This function needs to be used in conjunction with the central control board.</p>	<p>The default setting is 50, and the settable range is [10,90]. Can be set to OFF.</p> <p style="text-align: center;">50 41 OFF</p> <p>In PBG priority mains normal battery mode, switch to mains mode when the lithium battery SOC reaches the set value. After it is turned on, when the SOC is lower than the set point or the battery voltage is lower than the return-to-mains voltage point (see item 15), the inverter will switch to the mains mode. It can be set to OFF. At this time, the inverter will no longer switch from battery mode to mains mode according to the SOC situation.</p>

**Display Setting**

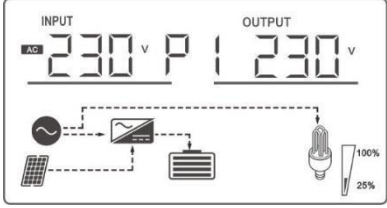
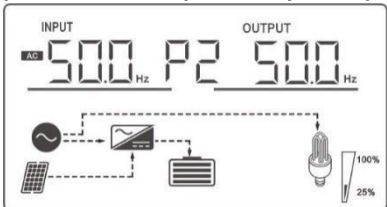
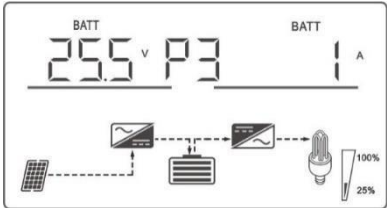
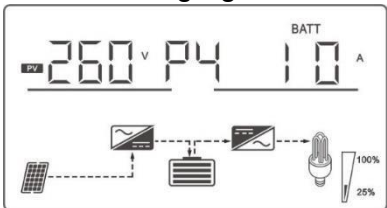
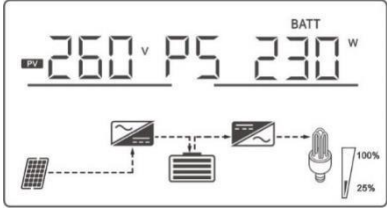
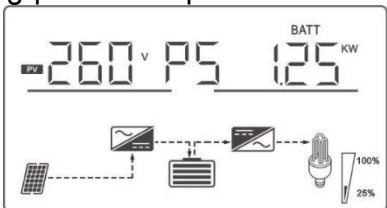
The LCD display information will be switched in turns by pressing  $\blacktriangle$ UP $\blacktriangle$  or  $\blacktriangledown$ DOWN $\blacktriangledown$  key. Includes: input/output voltage, input/output frequency, battery voltage/charging current, PV voltage/charging current, PV charging power, output active power, output apparent power, main CPU version, etc.

Selectable information	LCD display
------------------------	-------------

<p>Input voltage/Output voltage (Default Display Screen)</p>	<p>Input Voltage=230V, output voltage=230V</p> 
<p>Input frequency/ Output frequency</p>	<p>Input frequency=50Hz, Output frequency=50Hz</p> 
<p>Battery voltage and charging current</p>	<p>Battery voltage=25.5V, charging current =1A</p> 
<p>PV voltage and PV charging current</p>	<p>PV voltage=260V, PV charging current =10A</p> 
<p>PV voltage and PV charging current</p>	<p>When the PV charging power is lower than 1kW, the Pv charging power in unit of W will present xxx W like below chart</p> 
	<p>When PV charging power is higher than 1kW (<math>\geq 1kW</math>), the PV charging power will present xx KW like below chart</p> 

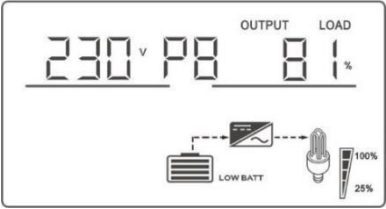
Output voltage/output active power	<p>When load is lower than 1kW, load in W will present xxx W like below chart.</p> 
	<p>When load is larger than 1kW (<math>\geq 1KW</math>), load in W will present x.x kW like below chart.</p> 
Output voltage/output apparent power	<p>When connected load is lower than 1kVA, load in VA will present xxx VA like below chart.</p> 
	<p>When load is larger than 1kVA (<math>\geq 1KVA</math>), load in VA will present x.x kVA like below chart.</p> 
Load percentage	<p>Load percent=81%</p> 

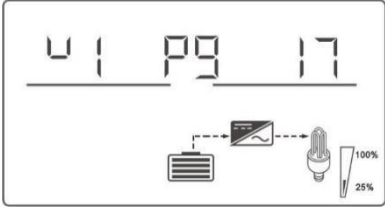
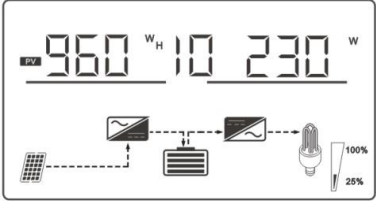
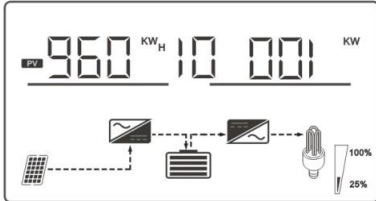
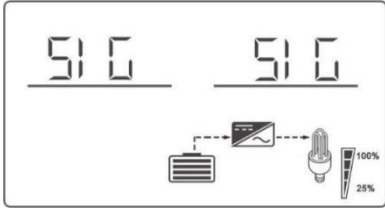

Main CPU version checking	<p>Main CPU version 00017.04</p> 
Pv cumulative power generation and Pv daily power generation	<p>On the left is Pv cumulative power generation, and on the right is Pv power generation on the same day. When Pv generation of that day (&lt;1KWH), Pv cumulative power generation in WH will display xxWH; Generation power per Pv day (&lt;1KW), the Pv generation power of the day in W will be displayed xxW.</p> 
	<p>On the left is Pv cumulative power generation, and on the right is Pv power generation on the same day. When Pv generation of that day (<math>\geq 1</math>KWH), Pv cumulative power generation in WH will display xxKWH; Generation power per Pv day (<math>\geq 1</math>KW), the Pv generation power of the day in W will be displayed xxKW.</p> 
Reserved	<p>Reserved</p> 

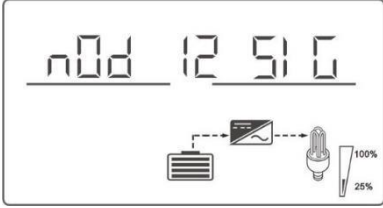
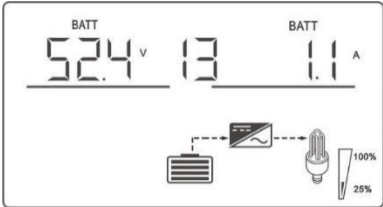
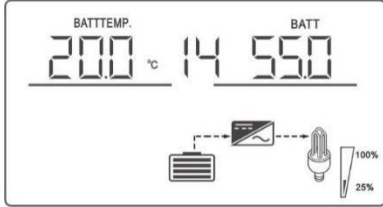
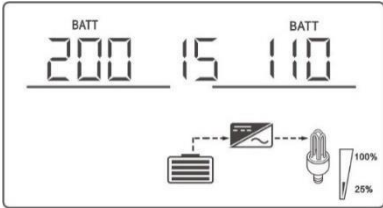

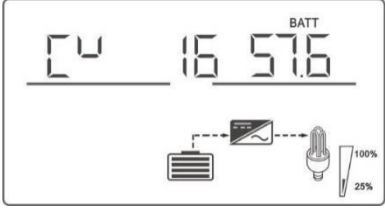
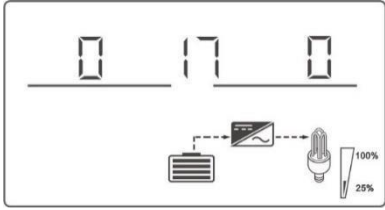

<p>Lithium battery networking status</p>	<p>When the right display is SIG, the battery pack is running in a single group; when it is displayed as flashing, the battery pack is establishing a multi-group series-parallel state.</p> 
<p>Information of lithium battery battery voltage &amp; current</p>	<p>The left side shows the BMS battery voltage information; the right side shows the BMS battery current information. When the BMS communication fails, the upper left and upper right are displayed as flashing ERR.</p> 
<p>Lithium battery battery temperature, SOC</p>	<p>The battery temperature information is displayed on the left; the battery SOC information is displayed on the right. When the BMS communication fails, the left and right sides are displayed as flashing ERR.</p> 
<p>Lithium battery battery capacity</p>	<p>The left shows the rated capacity; the right shows the current capacity. When the BMS communication fails, the left and right sides are displayed as flashing ERR.</p> 

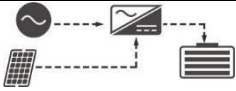
<p>Lithium battery constant voltage point</p>	<p>The left side shows the fixed letter CV; the right side shows the BMS constant voltage charging point. When the BMS communication fails, the flashing ERR is displayed on the right.</p> 
<p>Lithium battery fault warning information</p>	<p>The left side shows BMS alarm information; the right side shows BMS failure information. When the BMS communication fails, the left and right sides are displayed as flashing ERR</p> 

### Operating Mode Description



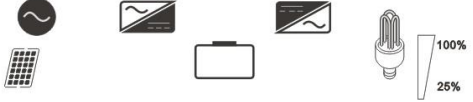

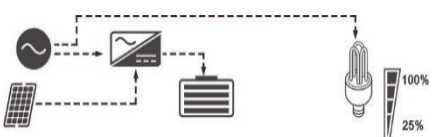
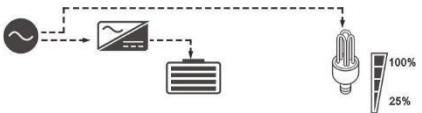
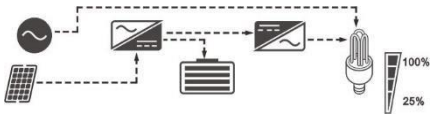
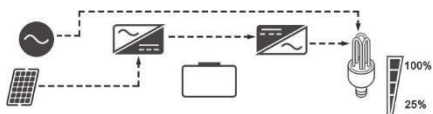

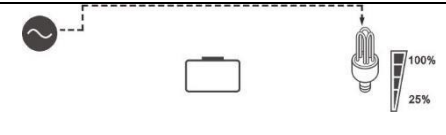
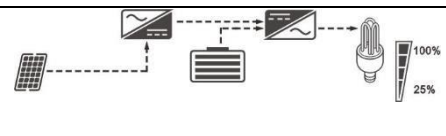
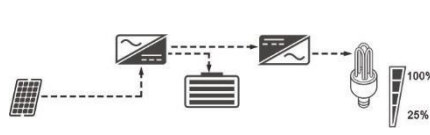
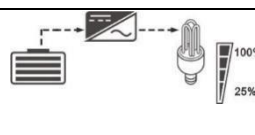
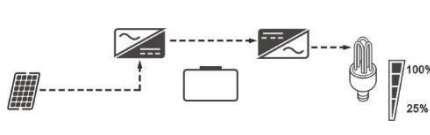









Operation mode	Description	LCD display
<p>Standby mode</p> <p><b>Note:</b></p> <p>*Standby mode: The inverter is not turned on yet but at this time, the inverter can</p>	<p>Charging by utility and PV energy.</p>	
	<p>Charging by utility.</p>	









charge battery without AC output.	Charging by PV energy.	
	No being charging.	
<b>Error mode</b> <b>Note:</b> *Error mode: Errors are caused by inside circuit error or external reasons such as over temperature, output short circuited and soon.	No output and no charge.	

Operation mode	Description	LCD display
<b>Utility Mode</b> <b>Note:</b> Utility mode: When the inverter is started, it supplies power to loads in mains mode.	The utility supplies power to the load while charging the battery, and the photovoltaic modules charge the battery.	
	The utility provides power to the load as well as charging the battery.	
	Select PV as the output priority and add batteries. If the PV module power is insufficient to provide power for all loads, the utility supply power to the loads.	
	Select PV as the output priority and do not connect batteries. If the power of the PV modules is insufficient to provide power for all loads, the utility supplies power to the loads. They don't charge the battery.	















	The utility provides power to the load but does not charge the battery.	
<b>Battery Mode</b> <b>Note:</b> Battery mode: When the inverter is started, the batteries and photovoltaic modules provide power to the load.	Power from battery and PV modules.	
	PV modules will supply power to the loads and charge battery at the same time.	
	Power from battery only.	
	Power from PV modules only.	

### Error Reference Code

Error Code	Error Event	Icon
01	Bus boost soft start failed	
02	Bus over-voltage	
03	Bus under-voltage	
04	over-current	
05	Over temperature	
06	Battery over-voltage	
07	Bus soft start error	
08	Bus short circuit	
09	INV soft start error	
10	INV over-voltage	
11	INV under-voltage	
12	INV short circuit	
13	Negative power protection	
14	Over-load error	
15	Model error	
16	No boot loader	
17	PV program burning	

19	Same serial number	
20	CAN communication error	
21	The battery voltage difference is too large.	
22	Input voltage difference is too large	
23	Input voltage frequency difference	
24	The output mode setting is abnormal	
25	Output out of sync	
26	BMS Trouble	

#### Warning Indicator

Warning Code	Warning Event	Icon flashing
50	Battery disconnected	
51	Battery under-voltage shutdown	
52	Battery under-voltage	
53	Battery charge short circuit	
54	Low power discharge	
55	Battery over-charge	
56	BMS lost	
57	Over temperature	
58	Fan error	
59	EEPROM fail	
60	Overload	
61	Abnormal generator waveform	
62	PV energy is weak. (5.5KVA)	
63	Synchronization loss	

64	Parallel settings are not compatible	64 <sup>△</sup>
65	The parallel version is not compatible.	65 <sup>△</sup>
66	Communication error of parallel equipment	66 <sup>△</sup>
67	There are differences in parallel power supply.	67 <sup>△</sup>
68	Low SOC shutdown	68 <sup>△</sup>
69	Low SOC	69 <sup>△</sup>

## SPECIFICATIONS

Table 1 Utility Mode Specifications

INVERTER MODEL	VMN5000-48
Input Voltage Waveform	Pure sine wave (utility or generator)
Input Voltage range (configurable)	170VAC~280VAC (UPS Mode) 120VAC~280VAC (INV Mode)
Utility low voltage transfer point	170Vac <sup>°</sup> 7V (UPS); 90Vac <sup>°</sup> 7V (Appliances)
Utility low voltage return point	180Vac <sup>°</sup> 7V (UPS); 100Vac <sup>°</sup> 7V (Appliances)
Utility high voltage transfer point	280Vac <sup>°</sup> 7V
Utility high voltage return point	270Vac <sup>°</sup> 7V
Max AC Input Voltage	300Vac
Rated Input Frequency	50Hz / 60Hz (Auto detection)
Lowest frequency conversion point	40° 1Hz
Highest frequency conversion point	42° 1Hz

Highest frequency return point	65° 1Hz
High Loss Return Frequency	63° 1Hz
Output Short Circuit Protection	Utility mode: Circuit breaker Battery mode: Circuit protection
Efficiency (Utility Mode)	>95% ( Rated R load, battery full charged )
Transfer Time	10ms
Output power derating: When AC input voltage drops to 170V, the output power will decrease.	<p>Output Power</p> <p>Rated Power</p> <p>50% Power</p> <p>90V 170V 280V Input Voltage</p>

Table 2 Inverter Mode Specifications

INVERTER MODEL	VMN5000-48
Rated Output Power	5KW
Output Voltage Waveform	Pure Sine Wave
Rated output voltage (configurable)	208/220/230/240Vac° 5%
Output Frequency	50Hz
Peak Efficiency	93%
Overload Protection	102%-110%/1min; 110%-130%/10s; 130%-150%/3s; > 150%/0.2s
Surge Capacity	2* rated power for 5 seconds
Rated DC Input Voltage	48Vdc
Cold Start Voltage	46.0Vdc
Low DC Warning Voltage	
@ load < 50%	46.0Vdc
@ load ≥ 50%	44.0Vdc

Low DC Warning Return Voltage @ load < 50%	47.0Vdc
@ load ≥ 50%	46.0Vdc
Low DC Protection Voltage @ load < 50%	43.0Vdc
@ load ≥ 50%	42.0Vdc
High DC Recovery Voltage	62Vdc
High DC Protection Voltage	63Vdc
No Load Power Consumption	62W

Table 3 Charge Mode Specifications

Utility Charging Mode	
<b>INVERTER MODEL</b>	VMN5000-48
Charging Algorithm	3-Step
AC Charging Current (Max)	80Amp (@VI/P=230Vac)
Charging voltage (Flooded Battery)	58.4Vdc
Charging voltage (AGM / Gel Battery)	56.4Vdc
Floating Charging Voltage	54Vdc
Photovoltaic charging mode	
<b>INVERTER MODEL</b>	VMN5000-48
Max. PV Array Power	5500W
Starting Voltage	150Vdc +/- 10Vdc
PV Array MPPT Voltage Range	120~430Vdc
Max. PV Array Open Circuit Voltage	450Vdc
Max Charging Current	80Amp

Table 4 General Specifications

<b>INVERTER MODEL</b>	VMN5000-48
Operating Temperature Range	-10' C to 50' C
Storage temperature	-15' C~ 60' C
Humidity	5% to 95% Relative Humidity (Non-condensing)
Dimension (D*W*H), mm	446*320*128
Packing size (D*W*H), mm	535*415*215
Net Weight, kg	9.2



## TROUBLE SHOOTING

Problem	LCD/LED/Buzzer	Explanation / Possible cause	What to do
Unit shuts down automatically during startup process.	LCD/LED and buzzer will be active for 3 seconds and then complete off.	The battery voltage is too low (<1.91V/Cell)	Re-charge battery. Replace battery.
No response after power on.	No indication.	The battery voltage is far too low.<1.4V/Cell Internal fuse tripped.	Contact repair center for replacing the fuse. Re-charge battery. Replace battery.
Utility exist but the unit works in battery mode.	Input voltage is displayed as 0 on the LCD and green LED is flashing.	Input protector is tripped	Check if AC breaker is tripped and AC wiring is connected well.
	AC LED is flashing.	Insufficient quality of AC power. (Shore or Generator)	Check if AC wires are too thin and/or too long. Check if generator (if applied) is working well or if input voltage range setting is correct. (UPS Appliance)
	AC LED is flashing.	Set PV priority as the priority of output source.	Change output source priority to Utility first.
When the unit is turned on ,internal relay is switched on and off repeatedly.	LCD display and LED are flashing	Battery is disconnected.	Check if battery wires are connected well.
Buzzer beeps continuously and red LED is on.	Fault code 14/60	Overload error. The inverter is overload 105% and time is up.	Reduce the connected load by switching off some equipment.
	Fault code 12	Output short circuited.	Check if wiring is connected well and remove abnormal load.
		Temperature of internal converter component is over 120' C.	Check whether the air flow of the unit is blocked or whether the ambient temperature is too high.
	Fault code 05/57	Internal temperature of inverter component is over 100' C.	
	Fault code 06	Battery is over-charged.	Return to repair center.
		The battery voltage is too high.	Check if spec and quantity of batteries are meet requirements.
Fault code 58	Fan fault	Replace the fan.	

The buzzer keeps beeping and the red light is on.	Fault code 10/11	Output abnormal (Inverter voltage below than 190Vac or is higher than 260Vac)	Reduce the connected load. Return to repair center
	Fault code 01/02/03/07/08/09/15/16/53/59	Internal components failed.	Return to repair center.
	Fault code 20	In parallel mode, CAN bus communication is abnormal	Check whether the parallel line is disconnected or poor contact.
	Fault code 21	In parallel mode, the battery voltage difference of different equipment is too large.	Check if the battery packs are connected in parallel
	Fault code 22	In parallel mode, the input voltage difference of different equipment is too large.	Check whether the input is in the same phase and connected together.
	Fault code 23	In parallel mode, the input voltage frequency difference of different equipment is too large.	Check whether the input frequency is abnormal
	Fault code 24	In the three-phase parallel mode, there is a lack of phase in the setting of different equipment parallel mode.	Check whether the setting conditions of three-phase operation are normal.
	Fault code 25	In parallel mode, the output voltage detection is out of synchronization	Check whether the output voltage has a large voltage difference
	Fault code 63	The synchronization is lost, the parallel board card is broken or the contact is bad.	Transfer equipment mode recovery, disconnection troubleshooting recovery
	Fault code 65	There is an incompatible version number in the parallel system.	Check to see if the version number is the same
Fault code 66	Communication failure of parallel equipment, slave equipment can not be detected under parallel system	Check whether the setting of the parallel equipment is correct and whether there is a problem with the parallel line.	

## PARALLEL OPERATION GUIDE

### Equipment running in parallel mode

1. Single-phase parallel operation: up to 9 devices. 5.5KVA/5KW supports maximum output power 45KW.
2. Three-phase parallel operation: up to 9 devices work together to support the use of three-phase devices. A maximum of 7 devices in any phase are running together, and at least one device is configured in the other two phases.

### Installation of equipment in parallel

When installing multiple devices, in order to facilitate air circulation and heat dissipation, please reserve enough space, the distance between the left / right side of the equipment is about more than 20CM, and the distance above / below is about more than 50CM, all the equipment is

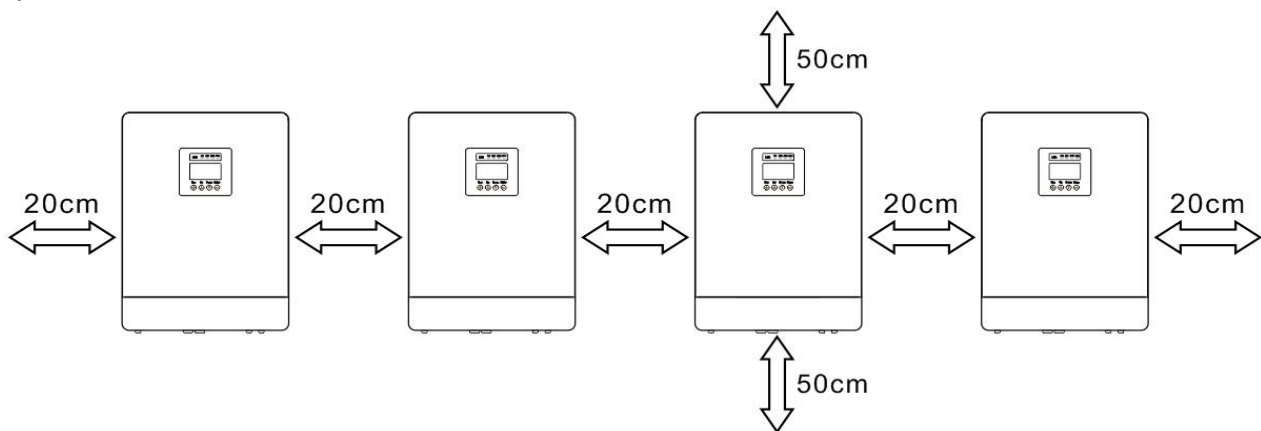

installed in the same horizontal plane, as shown in the following figure.

### Equipment parallel wiring

#### 1. Equipment battery cable

**Warning:** The battery wire of each device is connected separately to the battery pack for parallel connection, and the wire diameter and length are the same, otherwise there will be a voltage difference, resulting in abnormal operation of the parallel equipment!

#### Battery cable specification and fastening torque value of the equipment

Model	Cable specification	Fastening torque value
5.5KVA/48VDC	1*3AWG	2-3Nm

You need to connect the cables of each device together. Take the battery cable as an example: you need to use a connector or bus as a connector to connect the battery cable together, and then connect to the battery terminal. The cable used from the connector to the battery should be X times the cable specification in the above table. "X" represents the number of devices connected in parallel. For the input and output lines of AC equipment, please follow the same principle.

## 2. Equipment AC input/output cable

**Warning:** Make sure all input / output lines of each device are always connected, otherwise it will cause equipment failure! Please install the circuit breaker on the battery and AC input / output side to facilitate the safe disconnection of the equipment during maintenance. The recommended installation location of the circuit breaker is shown in the connection diagram!

### Equipment AC input / output line specification and fastening torque value

Model	Cable specification	Fastening torque value
5.5KVA/230VAC	12AWG	1.2-1.6Nm

## 3. Recommended breaker specification for equipment battery

**Note:** If only one circuit breaker is used on the battery side of the entire system, the rating of the circuit breaker should be X times the current of 1 device. "X" indicates the number of devices connected in parallel!

### Recommended breaker specification for equipment battery

Model	Specification of 1 equipment circuit breaker
5.5KVA/48VDC	150A

#### 4. Specification of recommended breaker for AC input of single-phase parallel system

Model	2 Devices	3 Devices	4 Devices	5 Devices	6 Devices	7 Devices	8 Devices	9 Devices
5.5KVA/ 230VAC	80A/ 230VAC	120A/ 230VAC	160A/ 230VAC	200A/ 230VAC	240A/ 230VAC	280A/ 230VAC	320A/ 230VAC	360A/ 230VAC

**Note:** For single-phase systems, a 40A circuit breaker can also be installed at the AC input of each device. For three-phase systems, when using a 4-pole circuit breaker, the current rating should match the phase current with the maximum capacity!

#### 5. Recommended battery pack capacity for equipment

**Warning:** All devices will share the same battery pack, otherwise the equipment will prompt the fault alarm!

#### Recommended battery pack capacity

Model	2 Devices	3 Devices	4 Devices	5 Devices	6 Devices	7 Devices	8 Devices	9 Devices
5.5KVA/48VDC	400AH	600AH	800AH	1000AH	1200AH	1400AH	1600AH	1800AH

#### 6. PV input connection

For PV connection, please refer to the relevant guidelines in the user manual of a single equipment.

**Note:** The PV of each device must be input independently. Parallel input of PV wiring between different devices will damage the equipment!

## Single-phase parallel operation.

### 1. Two devices are connected together: Power connection diagram

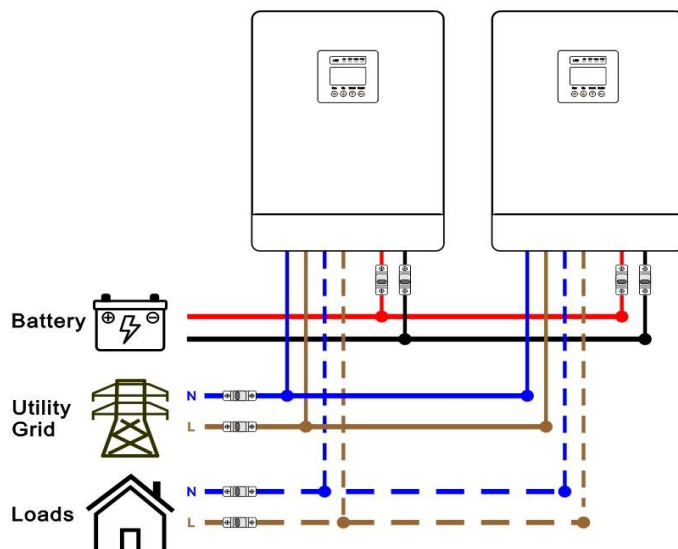

### Communication connection diagram

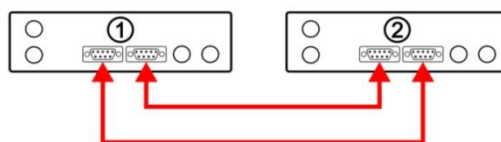

## 2.Parallel operation of three devices: diagram of power connection

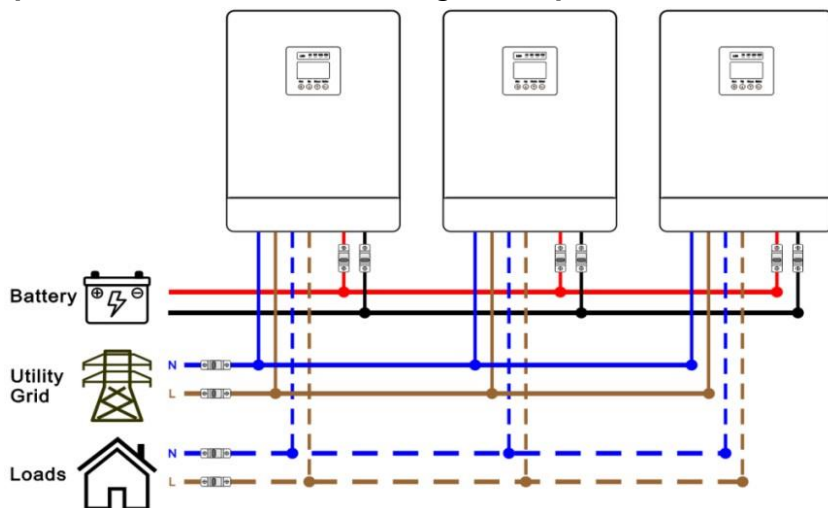

## Communication connection diagram

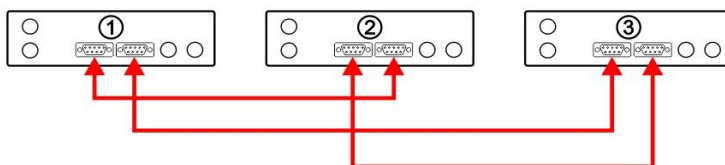

Note: the single-phase parallel connection mode of multiple devices can be expanded according to the connection method of two or three devices, and a maximum of 9 devices can be run in parallel.

## Three-phase parallel operation.

### 1. One device per phase: Power connection diagram

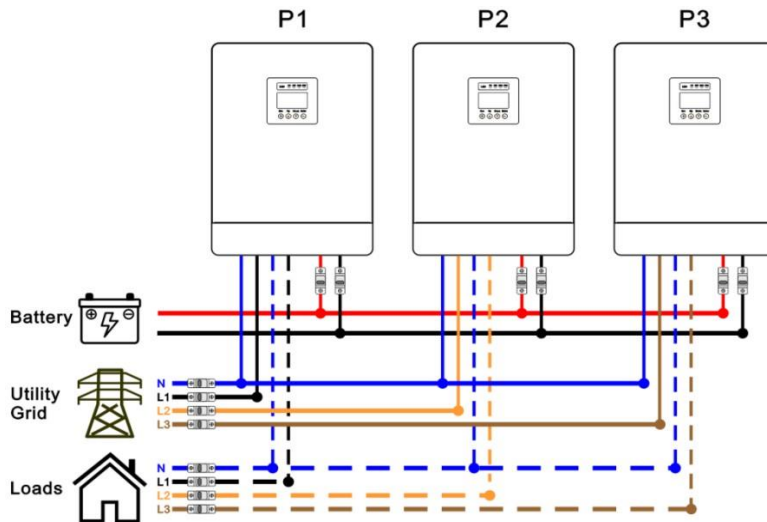

### Communication connection diagram

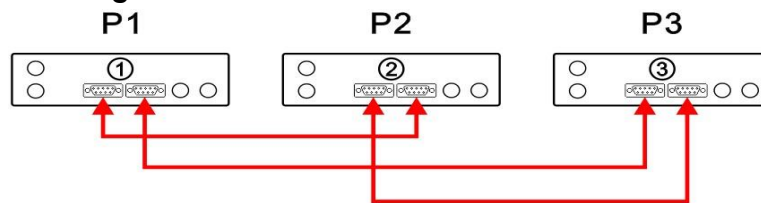

### 2. Two devices in the first phase and only one device in the remaining phase: Power connection diagram

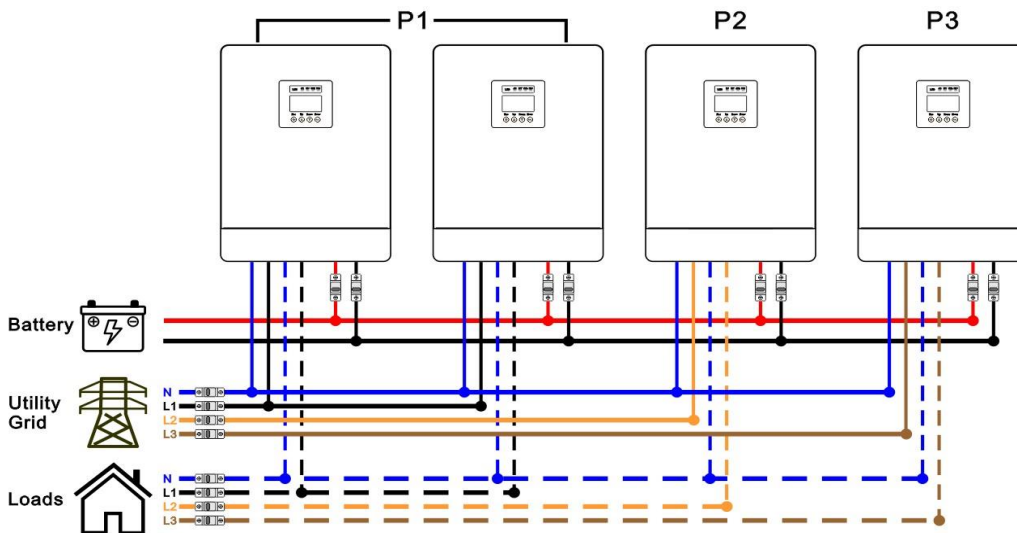

### Communication connection diagram

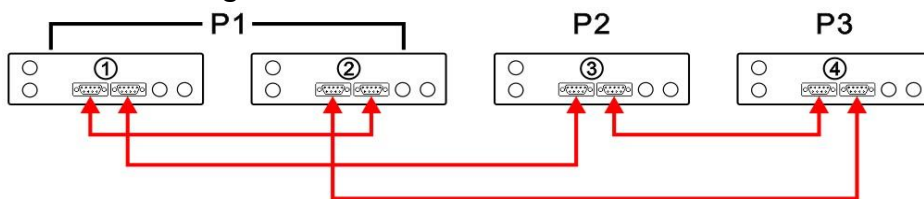



**3. First phase / second phase two devices, third phase one equipment: Power connection diagram**

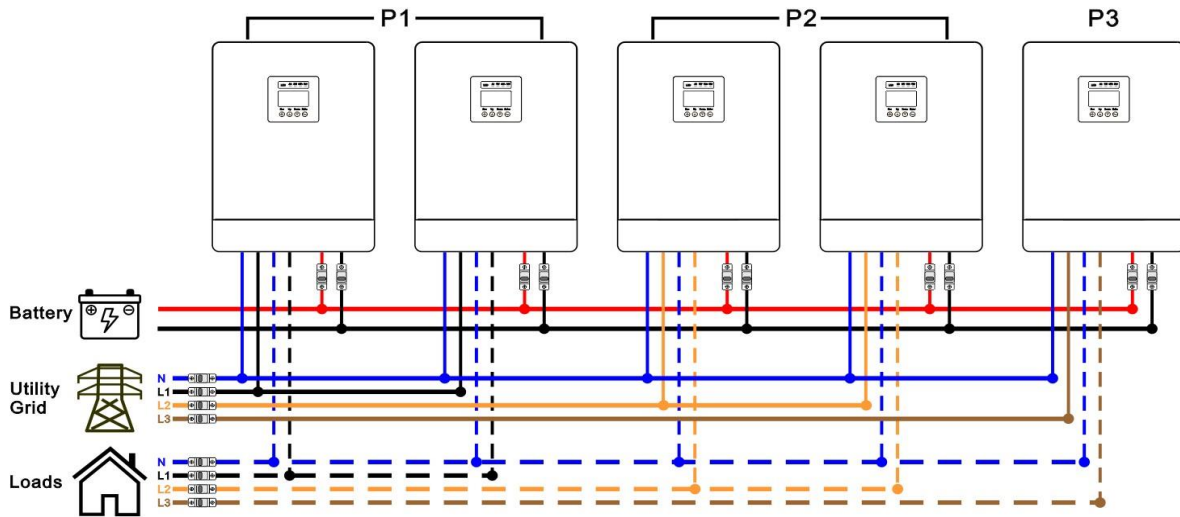

**Communication connection diagram**

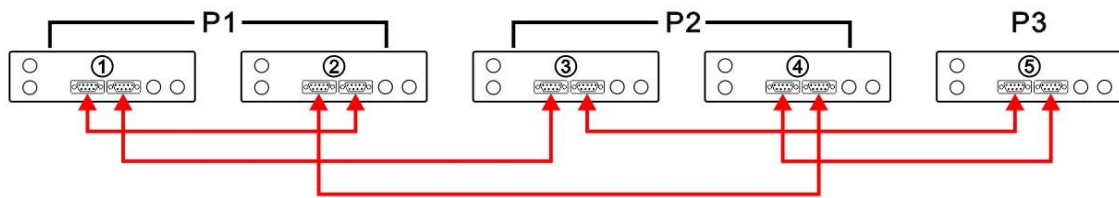

**4. Three devices in the first phase and only one device in the other two phases: Power connection diagram**

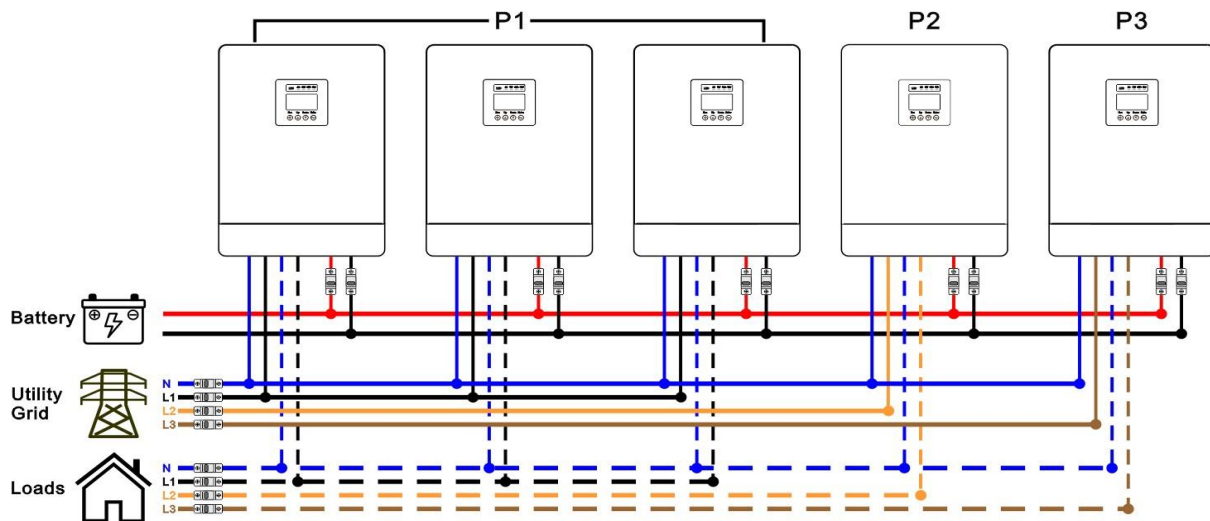

**Communication connection diagram**

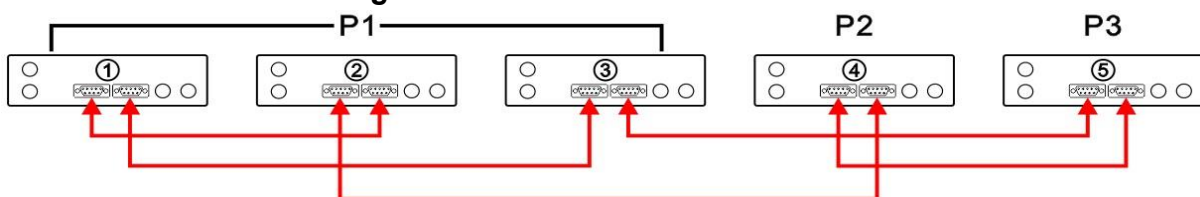

**5. There are two devices in each phase: Power connection diagram**

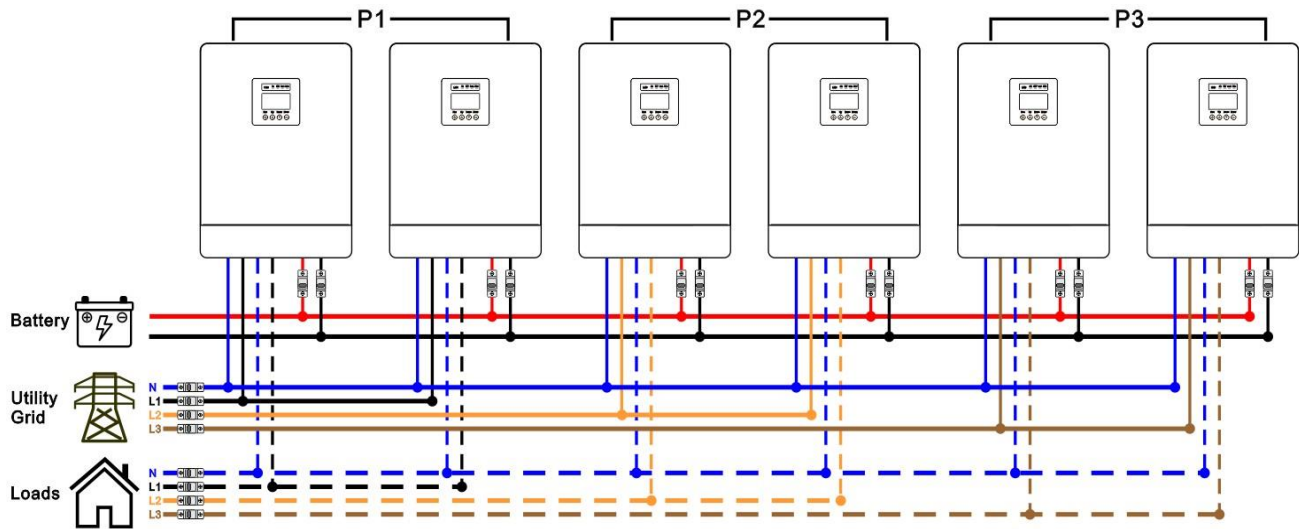

**Communication connection diagram**

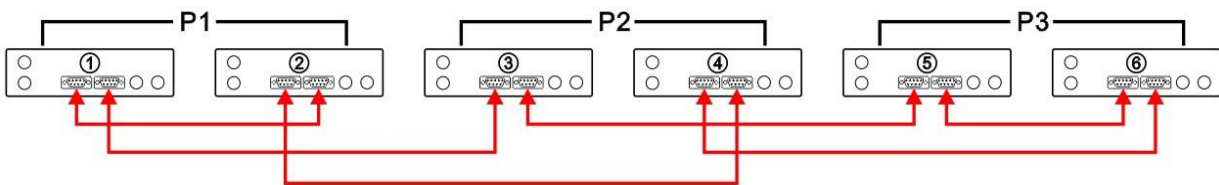

**6. Three devices in the first phase, two devices in the second phase, and one equipment in the third phase: power connection diagram**

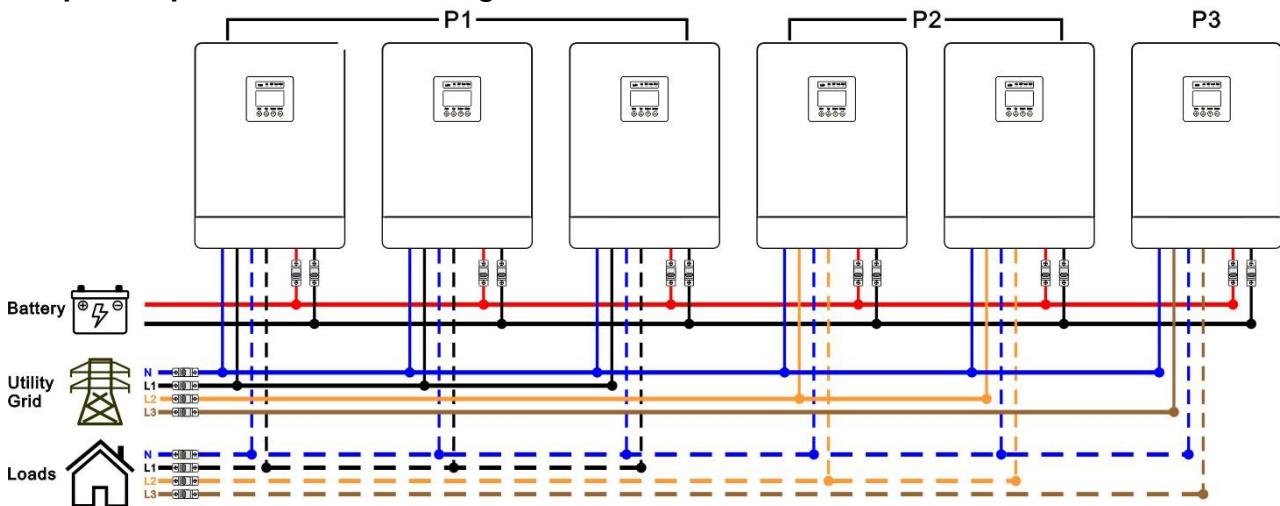

**Communication connection diagram**

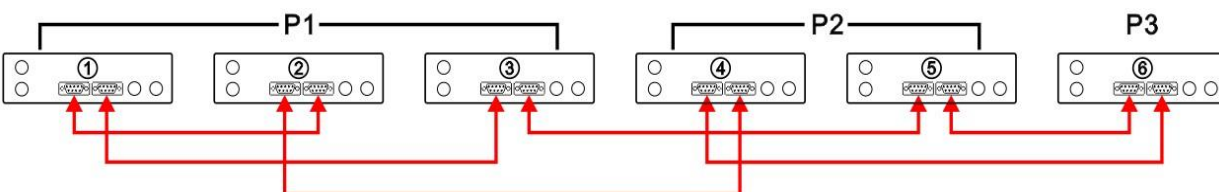

## 7. Four devices in the first phase and one device in the other two phases: Power connection diagram

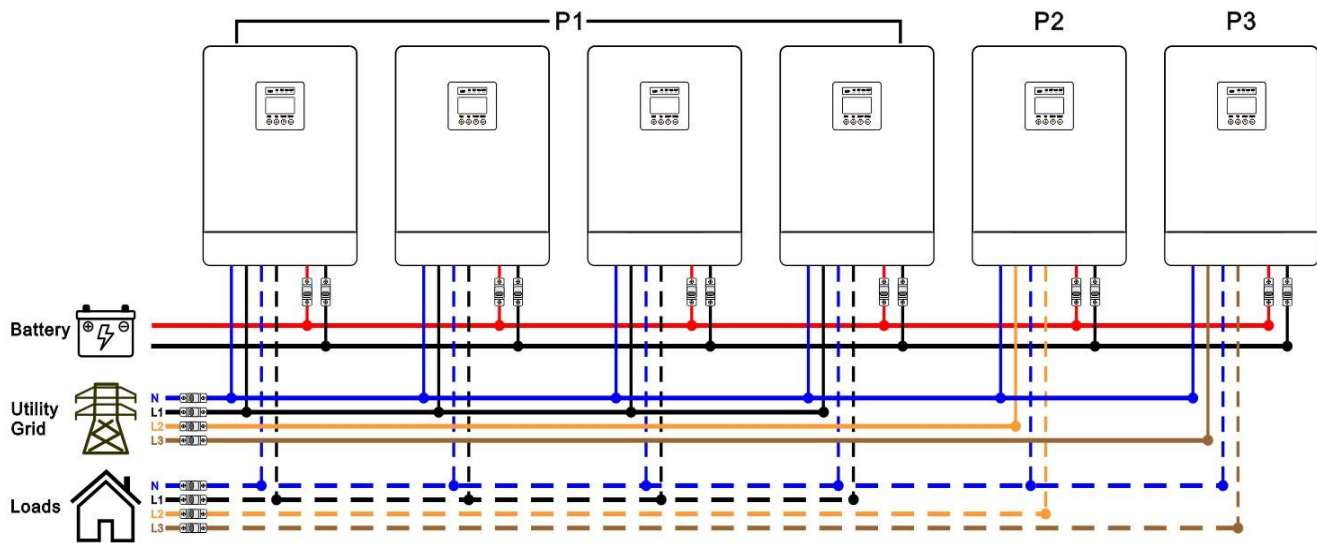

## Communication connection diagram

